

INSTALLATION MANUAL
for Lay-in Modular Ceiling



Storage and Handling

- Ceiling panels must be kept clean, dry, and protected from the elements. Remove the panels from the cartons 24 hours before installation to acclimatize to interior conditions.
- The installation site must be free from debris and dust.
- Irrespective of varying temperature and humidity recommendations which vary from product to product, all products must be stored in a interior space and not exterior space.



FRAGILE



UP

Mineral Fibre



Metal & Soft fibre



Opening a grid carton

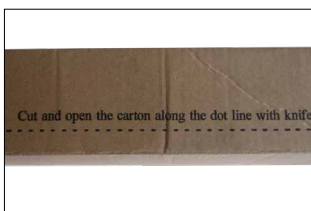

Step 1: Identify dotted line



Step 2: Cut along dotted line



Step 3: Open from one side



Step 4: Ready to remove

Opening a mineral fibre tile carton

Armstrong recommends that RH 99, 90 & 80 products are to be opened and left to acclimatize for 24 hours before fixing. This makes the tiles dry and hard.



Wrong box opening method



Step 1: Cut the polythene film



Step 2: Remove the polythene film



Step 3: Remove the tile



Index

Section I: Standard Modular Ceiling Installation and Maintenance

9 Step Ceiling Installation Procedure.....	4
MetalWorks Tiles Cutting Procedure.....	17

Section II: Components, Safety and Tools

Ceiling Components.....	18
Safety & Precautions.....	19
Tools.....	21

Section III: Appendix

Maintenance.....	22
Check list for Lay-in Ceiling Installation.....	23
Glossary.....	39

Note: The installation procedure for MetalWorks lay-in ceiling systems is similar to that for Mineral fibre ceiling systems, except for the procedure required to cut MetalWorks tiles, which is given on page 17.

9 Step Ceiling Installation Procedure

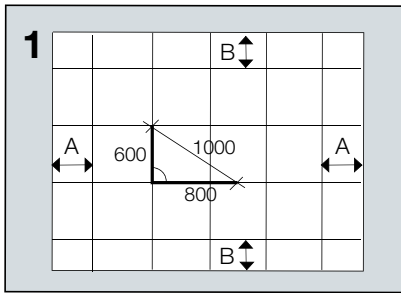

1. Planning grid layout

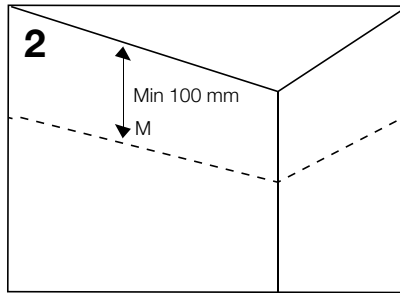

2. Mark perimeter trim lines

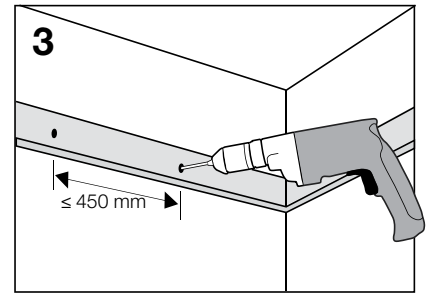

3. Installing perimeter trims (Wall angle)

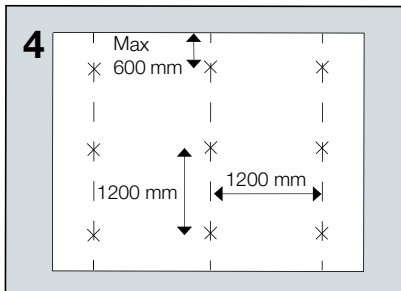

4. Mark hanger positions

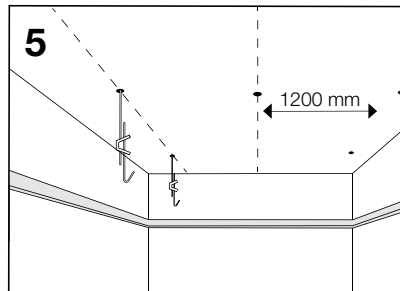

5. Installation of hangers

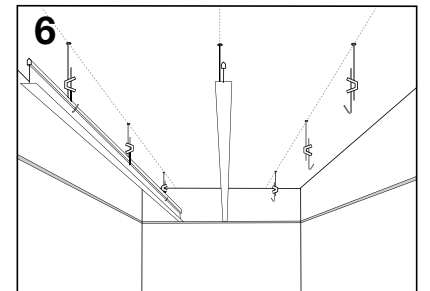

6. Installation of Main Runners

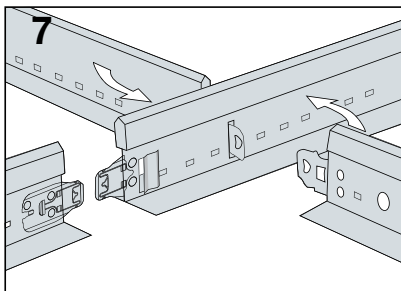

7. Cross Tees installation

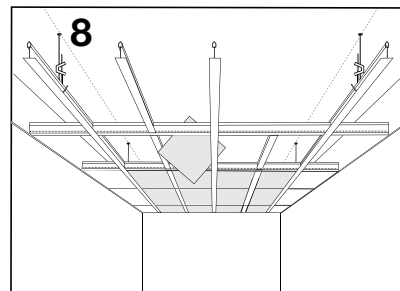

8. Installation of field and service tiles

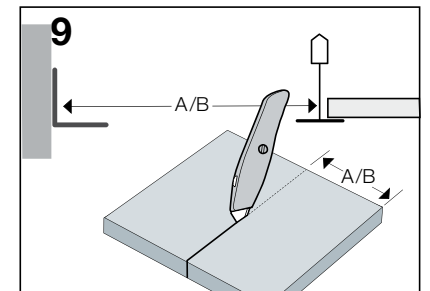

9. Measure and cut border tiles

Important Note: Please read Section II: Components, Safety and Tools before commencement of ceiling installation.

Sketch showing basic ceiling layout and placing of the components

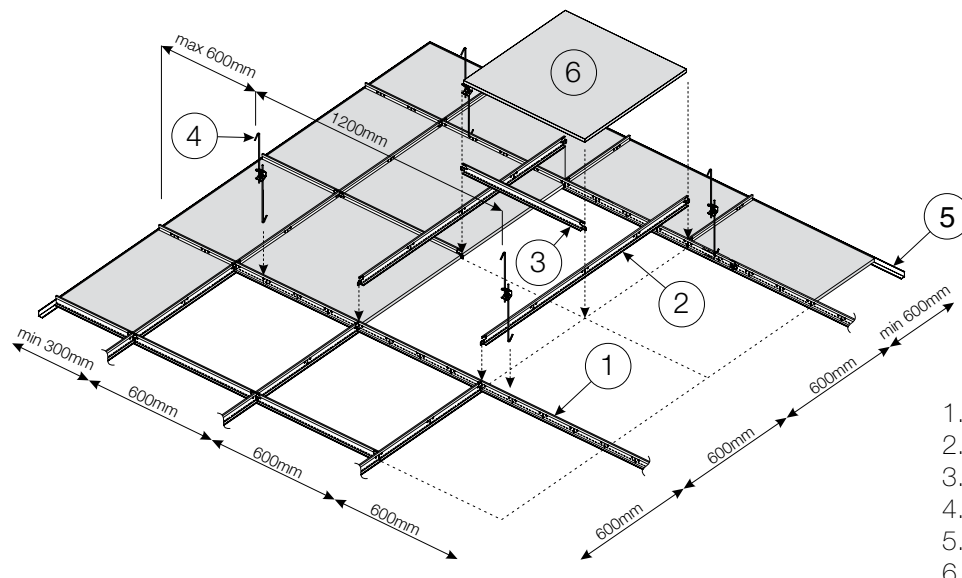

- 1. Main Runner
- 2. 1200mm Cross Tee
- 3. 600mm Cross Tee
- 4. Suspension System
- 5. Wall Angle
- 6. Tile

Step 1: Planning Grid Layout

A) Wall to wall (with field and border tiles)

This is one of the most important step before commencement of actual ceiling installation. Here grid layout is arrived by taking into consideration room dimensions {length(l) x breadth(b) x height(h)}

Points to remember: In practical conditions, often the room dimensions are not exactly square in dimensions.

Thumb \curvearrowright rule: Armstrong recommends to have border cut tiles greater than half the size of the ceiling tiles on all four sides of the wall.

Refer layout for diagram 1.1

Ceiling Module: 600mm x 600mm

Room dimensions: 4320mm x 2700mm (l x b)

Tiles calculation l: 4320mm

= 7 full tiles + 2 x 60mm cut tiles (\times incorrect calculation)

= 6 full tiles + 2 x 360mm cut tiles (\checkmark correct calculation)

Note: Please follow the above method for breadth border cut tile calculation.

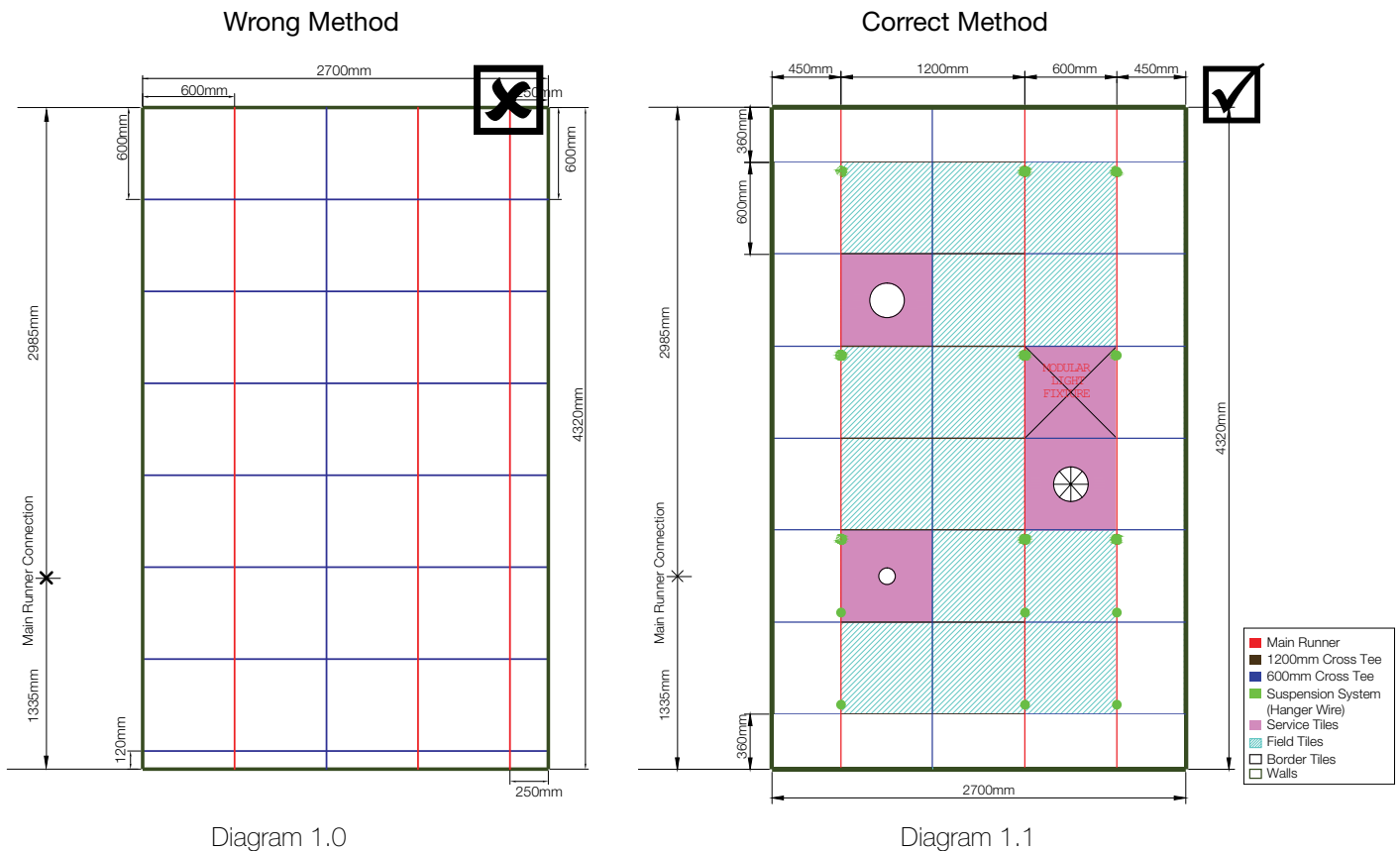

KEY POINT TO NOTE

Border tiles should be more than ≥ 300 mm

Step 1: Planning Grid Layout

B) With Plaster bulk heads (full tiles module)

Plaster bulk heads are used to design spaces to enclose full border tiles and enclose vertical grilles for HVAC.

Below mention is a simple thumb rule to calculate ceiling installation with full border tiles.

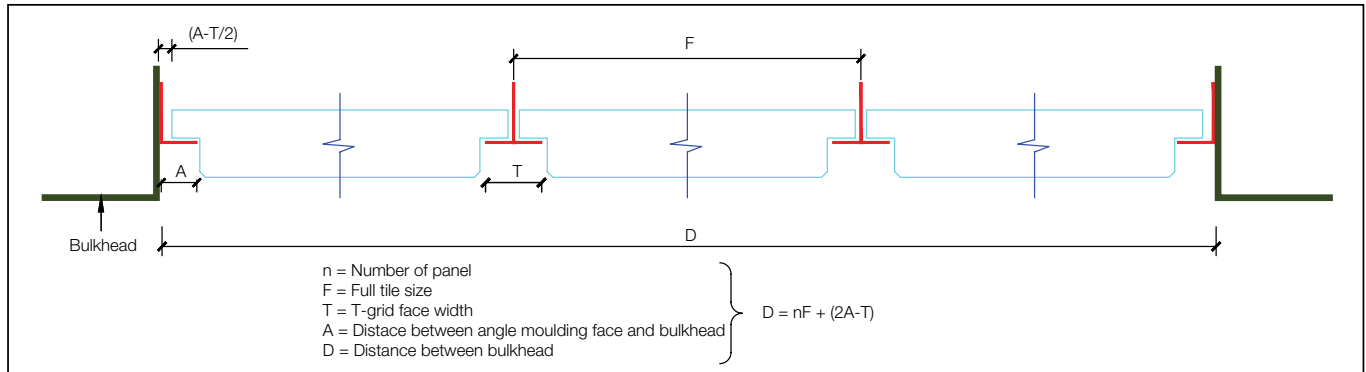

Diagram 1.2

Assuming, we are developing a module of 3600mm X 3600 mm i.e 6 tiles X 6 tiles within the plaster bulk head.

- Most often one would take an internal measurement, between the bulkheads of 3600mm X 3600mm. But this is an incorrect method and while doing final installation, you may end up cutting the border tiles on all the four sides.
- Thumb rule: Add two sides wall angle width and deduct the width of the main tee to get the extra length.
- Assume we use 19mm wall angle and 24mm grid facing, then the overall length should be 3614mm to achieve the full tile visual.

Thumb rule calculation

Wall Angle		Steel Angle Face Width	
Description	Size (mm)	15mm	24mm
Wall Molding	19x19x3000mm	Add 23mm	Add 14mm
Shadow Molding	19x7x7x14x3600mm	Add 13mm	Add 04mm
Wall Molding	32x24x3000mm	Add 33mm	Add 24mm
Aluminium Wall Molding	19x25x3000mm	Add 35mm	Add 26mm
Stainless Steel Wall Molding	19x32mm	Add 49mm	Add 40mm
Wall Molding	22x22x3000mm	Add 29mm	Add 20mm

Note: The addition to the original length or breadth will avoid the need for border tiles.

KEY POINT TO NOTE

Arriving at bulkhead dimensions critical for full tiles module

Step 2: Mark Perimeter Trim Lines

- Measuring the ceiling height is the most crucial stage before commencing installation.
- The minimum plenum height from the ceiling slab should not be less than 100mm for lay-in system.
- The reference ceiling level should be established by the main contractor with the help of all other services vendors like light fixtures, Air condition grilles, sprinklers, speakers etc.



- Using a plumb mark as a reference point, place line laser leveller on it. Then with the help of laser point, mark wall angle level on all sides of the room.

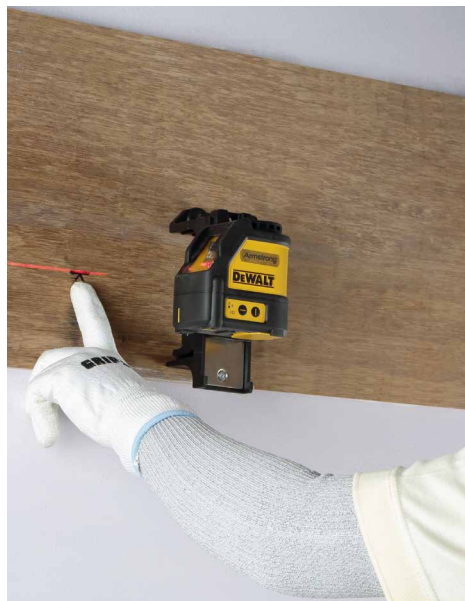

**KEY POINT
TO NOTE**

Line laser leveller
saves time and
ensures precision

Step 3: Installing Perimeter Trims (Wall Angle)

- The marking with the help of line laser leveller has to be done above the wall angle level on all the walls.



- Post marking used hand drill to installed the wall angle.
- The first and the last fasteners on wall angle should be installed at 150mm from the wall (see for details recommended fastener on page no.19).
- Subsequent fasteners to be installed at 450mm spacing in between.



**KEY POINT
TO NOTE**

Secure to wall at
450mm maximum
centres

- At the corners of the room, the conjunction area of wall angle should be miter cut for a clean finish

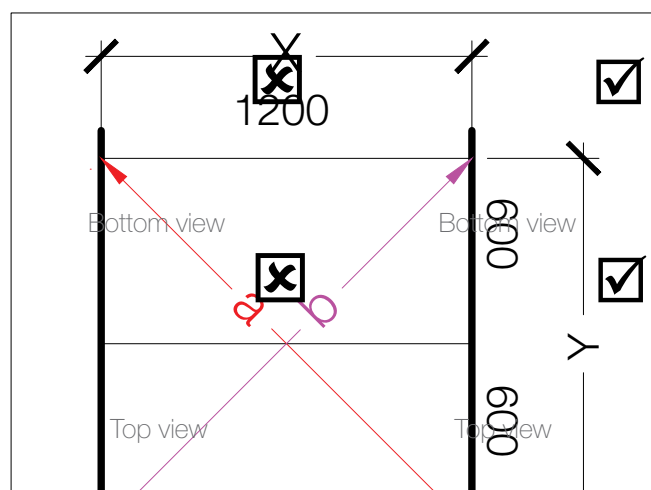

Step 4: Mark Hanger Positions

- The hanger on the main runner should be placed at or within 600mm distance from the wall angle (450mm is recommended in case of heavier ceilings) and then subsequently at 1200mm centres.

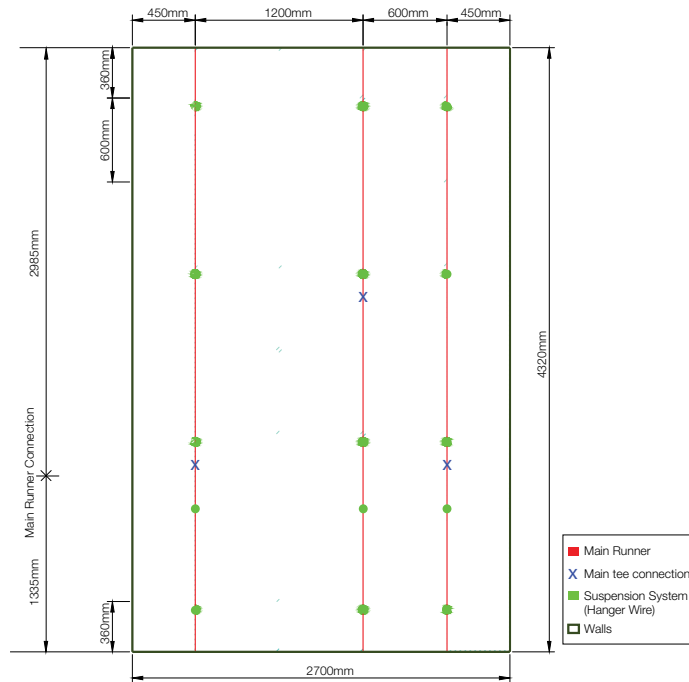

Diagram 1.0

- There should also be a hanger within 150mm of any main runner to runner connection.

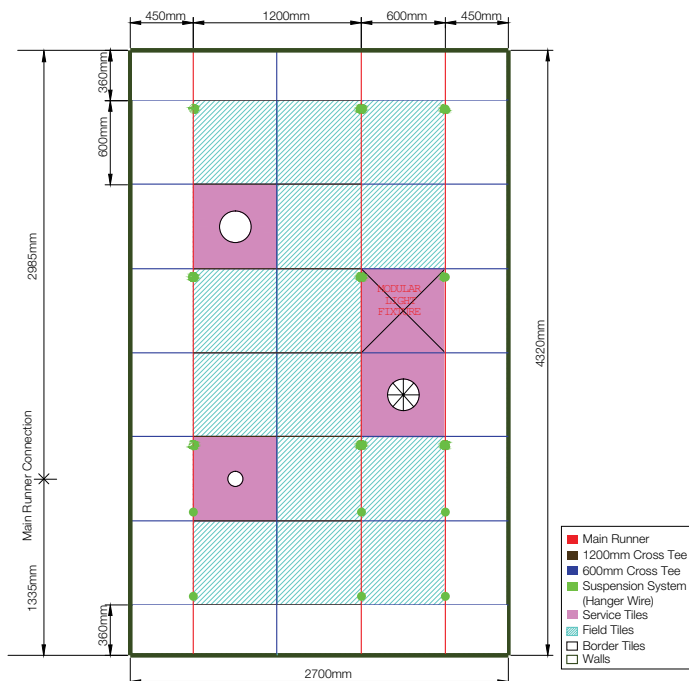

Diagram 1.1

KEY POINT TO NOTE

Hanger position must be within 600mm distance from the wall

KEY POINT TO NOTE

Hanger position must be within 150mm distance of every main runner connection

Step 5: Installation of Hangers

- Use a rotary hammer machine to drill and install the hangers from the concrete ceiling slab.

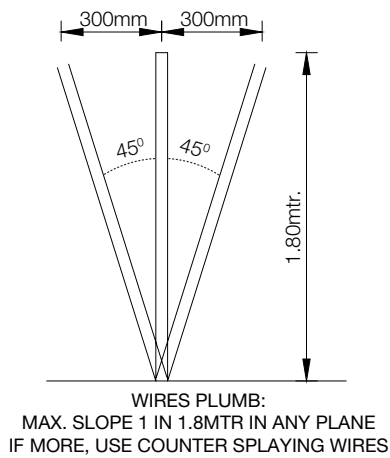

Diagram 1.3



**KEY POINT
TO NOTE**

Use counter
splaying wires if
hanger length is
 $\geq 1.8\text{mtr.}$

- If the hanger wire plumb more than 1.8 meter then use counter splaying wire refer above diagram.
- In counter splaying, two hanger wires from the structural slab form an angle of 45° near the main runners. One suspension countering another in the same plane.
- Install the hanger wire as per the position in the diagram 1.1.
- Suspension hanger wire shall be pre-straightened with minimum 2.5mm dia (# 12 Gauge).
- Insert wire of required length into hanger wire hole and encircle the wire 3 times within 75mm.

Installation under AC duct

- If AC duct is greater than 1200mm in length, then ensure you suspend a separate bracket under the duct and from it, a hanger-wire can be suspended for ceiling installation.

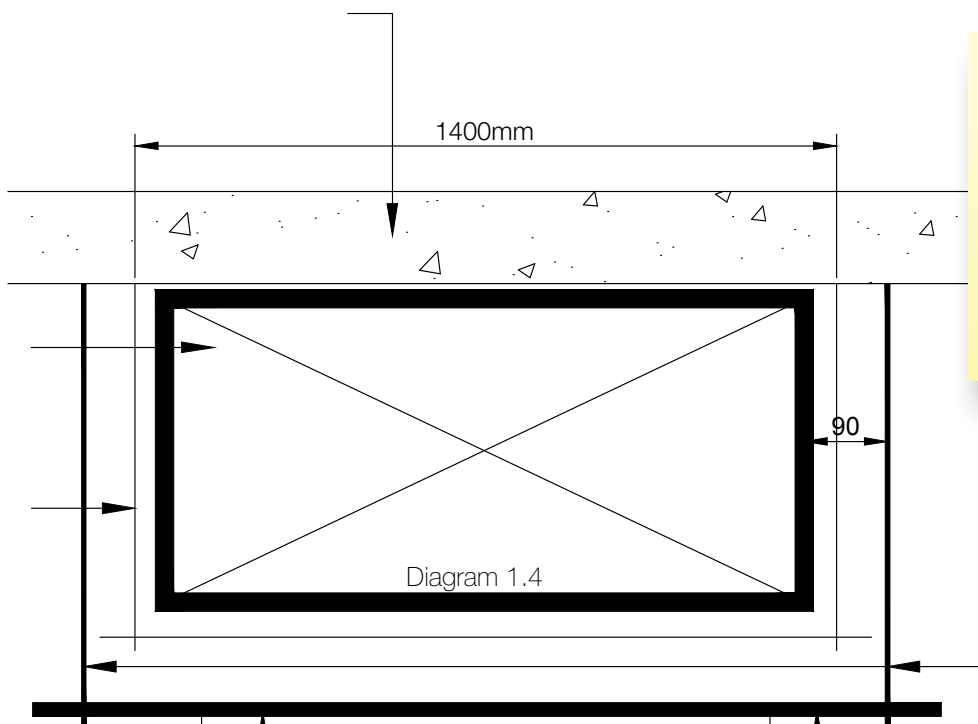

**KEY POINT
TO NOTE**

Ensure suspension
free from services

Step 6: Installation of Main Runners

- Run a string line the length of your first main runner offset to the edge flange. This will help to keep the main runner set distance of the wall.

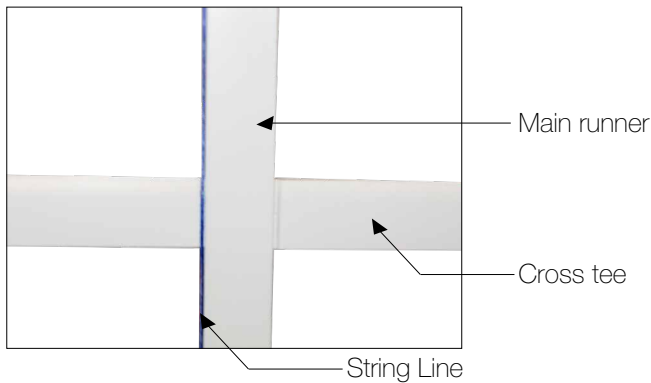

**KEY POINT
TO NOTE**

Use only aviation snip for precise cutting of main runners

- Cut the main runner to the length with respect to the border tile, so that the rout hole on the adjacent main runner matches.
- E.g. As per **diagram 1.5**, the main runner will be cut at 15 mm using an aviation snip cutter to ensure that the rout hole will be at a distance of 360 mm.

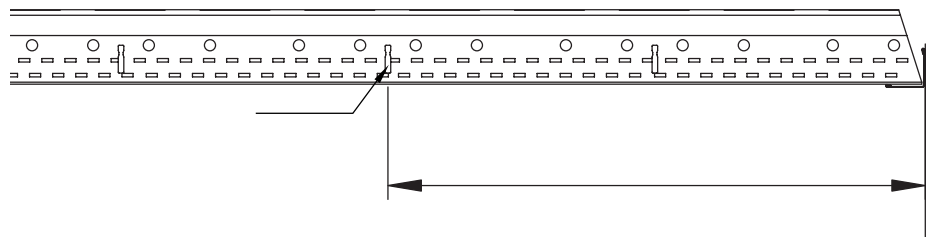

Diagram 1.5

- Cut the main runner at inclination of 30-45 degree to avoid obstruction of protruding screws.

Armstrong provides following grids.

Grids	Rout Hole Interval (mm)	Distance of 1st Rout Hole from the End Clip (mm)
Prelude 32	150mm	75mm
Prelude 38	150mm	75mm
Prelude 43	100mm	50mm
Suprafine 32	150mm	75mm
Suprafine 38	150mm	75mm
Suprafine 43	100mm	50mm
Silhouette 38	600mm	300mm
Silhouette 45	600mm	300mm
Select 38	600mm	300mm
Select 45	600mm	300mm



- The first main runner should be less than 600mm from the perimeter wall.
- The distance between next main runner shall be at 1200 mm maximum.
- You may incline the first suspension system slightly to push the main runner in one direction so that the rout holes are better aligned.
- Hangers with hook clip options can be inserted in alternate direction on the main runner for better stability.
- Border cross tees should be more than 300mm but less than 600mm in length.

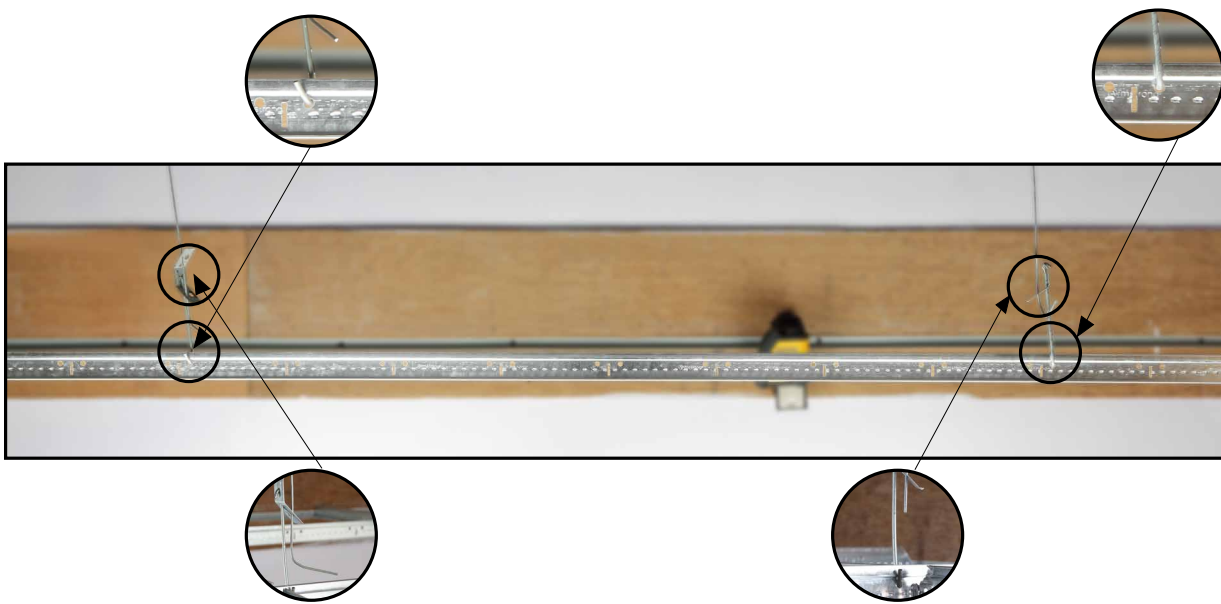

- Cut the excess portion or bend the wire as shown in the picture.
- Insert an additional row of main runner or alternatively suspend all border cross tees longer than 600mm.

KEY POINT TO NOTE
 Main runner and border cross tee should not be more than 600mm distance from the wall

Step 7: Cross Tees Installation

- As per diagram 1.1 (page 5) install border cross tee 448mm (2mm allowance is kept for cross tee to rest on the wall angle easily).
- Install border cross tees temporarily to the wall molding using a clamp to keep them intact.



- Install two 1200 cross tees between the two main runners at an distance of 600mm.
- A click sound confirms that the cross tee has been properly locked into the main runner.

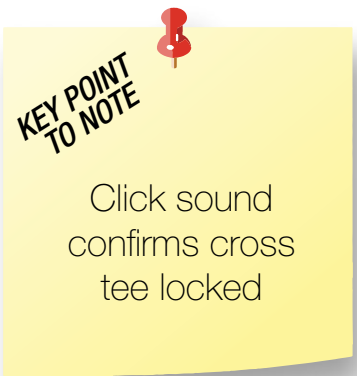

- Measurements should be taken diagonally in the 600 x 1200mm module. Both the diagonals must be of the same length.

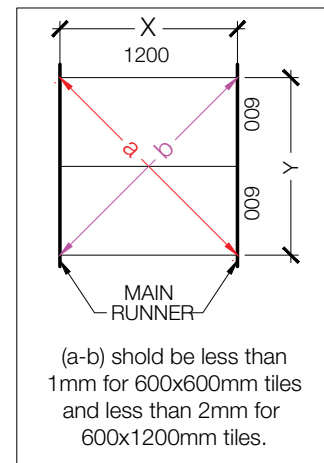
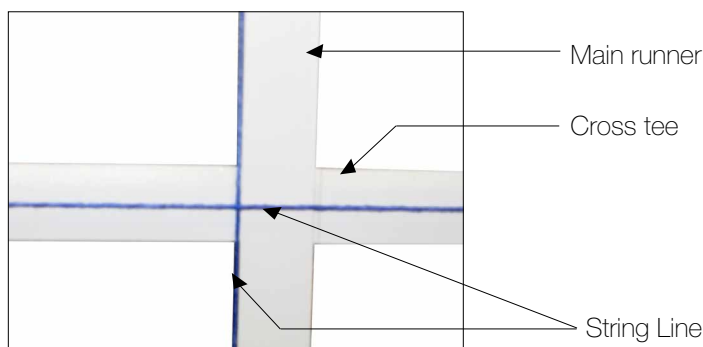

Diagram 1.6

- In case of any deviation in the measurement of the diagonals gently tap at the corners.
- This will ensure that the entire ceiling grids will be in a perfect shape.



- Once the system is in perfect shape run another string line at the first cross tee slot on the main runner to the far adjacent wall angle using the first two square mains as the guide. This ensure the tee rout holes on all the main runners stay in aligned.

Step 8: Installation of Field and Service Tiles

- Check the level once again using line laser leveller.
- Ensure that all the services placed on service tiles are tested and confirmed by the principal contractor. Only after that, laying of field tiles can be commenced.

- Use fresh / clean Gloves while installing the ceiling tiles.
- Ensure that there are no dust and stain marks on the gloves.



- While installing down lighters, spotlights, sprinklers, speakers, smoke detectors etc. 6mm plywood (patress backing must be placed on the grid).



Patress backing →

KEY POINT TO NOTE

Patress a must for installing services to avoid direct loading on ceiling system

- It is mandatory to independently suspend modular light fixtures.
- GI wire 2.5 mm is recommended to suspend the light fixtures.
- Hook Clips and Chains are not recommended.



Step 9: Measure and Cut Border Tiles

- Measure the border tile size.



- Mark the border size on back side of the tile.



- Use a grid or a steel ruler (2 ft long) to mark and cut the border tiles.



- While installing, slightly tilt the tile and gently rest it on the main runner and adjacent cross tee and wall angle.



**KEY POINT
TO NOTE**

Chalk the cut
edges of
border tiles

How to make tegular and curved shape edges on border tile

A) Tegular edge

- Use a sharp knife.
- Lay the tile on a smooth surface.
- Make vertical cut into face of the tile.
- Make horizontal cut to form tegular edge.



Installing end cap in tegular edge installation

- End cap ensures that a tegular look is achieved at the border.



- Lift the steel angle and insert the end cap between the tee and the wall angle.



- End cap ensures aligned level difference at the perimeter.



B) Curved shape (square edge)

- Use a sharp knife.
- Lay the tile on a smooth surface.
- Use a cardboard or plywood template.
- Mark outline of the template.
- Use a sharp knife to cut through.



Metalworks Tiles Cutting Procedure

- Measure and mark the line on the metal tile using a pencil.
- The bent edge of tile should be cut using aviation snip.
- Use a shear machine to cut the face of the metal tile.

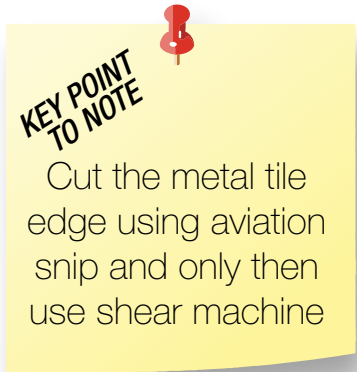

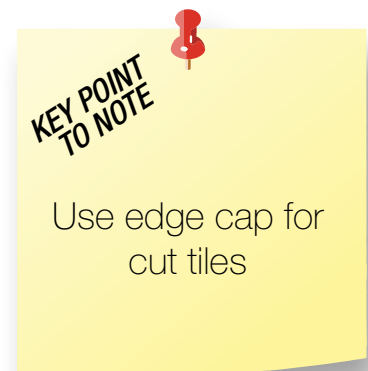
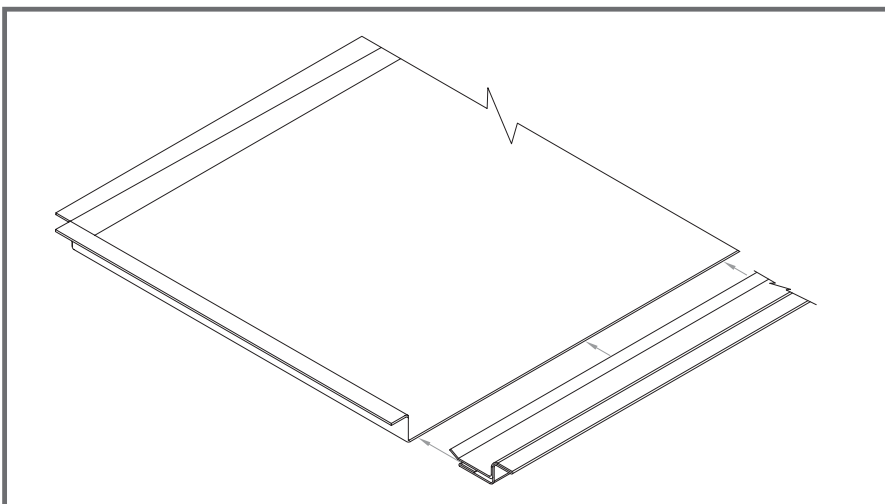

- Use an end profile for MetalWorks lay-in cut tiles.



- Slide the edge cap in to the cut tile. Install the tile into the ceiling grid.

Ceiling Components

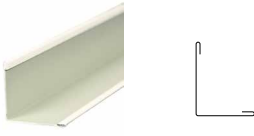
Wall angle and Shadow molding: Available in 3.6mtr. and 3mtr. lengths respectively

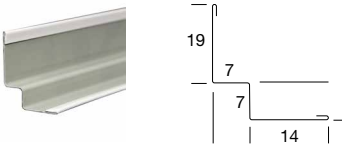
Section	Applicable Tile Edge Details
<p>'L' Angle</p> 	<ol style="list-style-type: none"> 1) Board (site cut or full tile) for wet-felt or soft 2) Tegular or Bevelled Tegular (site cut square) for wet-felt, soft or wood with cross tee supported by perimeter fill-in block 3) Tegular or Bevelled Tegular (site recut to recess edge) for wet-felt or soft with cross tee supported by perimeter trim 4) Bevelled Tegular (site cut square) on Silhouette steel angle with cross tee supported by perimeter trim
<p>'L' Angle</p> 	<ol style="list-style-type: none"> 1) Board (site cut or full tile) for Ceramaguard used in 100% RH areas and other applications using corrosion resistant steel angle 2) Metal clip-in tiles
<p>Shadowline</p> 	<ol style="list-style-type: none"> 1) Bevelled Tegular (site cut square) on Silhouette steel angle with cross tee supported by perimeter trim 2) Vector (site cut square) for Ultima wet-felt or Optra soft tiles with cross tee supported by perimeter upper ledge

*All above measurements in mm.

Main Runner: Available in 3.6mtr. and 3mtr. length respectively.

Cross Tees: Available in 1200mm and 600mm respectively.

Mineral fibre Lay-in tiles: Sizes available in 600x1200mm, 600x600mm and 300x1200mm.

Tile Edge Compatibility

Board/Square edge



Angle Tegular



Bevelled Tegular

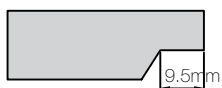

Silhouette Bevelled Tegular

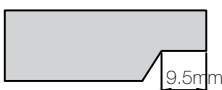

Grids/Edge

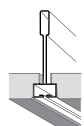
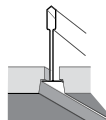
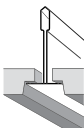
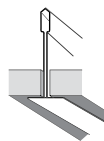

Flange

24mm face

24mm face

15mm face

15mm face (Silhouette)

Ceiling Components

Accessories: (refer accessories manual for more details)



Hook clip: This is a height adjustment clip to align the ceiling system and ensure it's rigidity.

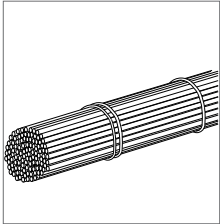

Hanger wire: 2.5mm pre-straightened wire to hang the suspended ceiling from the ceiling slab.



Anchor fastener: It is anchored into the ceiling soffit and used to suspend the GI wire.

Recommended fasteners:

- 1½ " screws/nails on wood
- Screws on metal surface.
- Expanded fasteners on concrete and brick wall surfaces.
- Fence staples for dry wall partitions.

Safety & precautions

Ladder safety:

Ladders are recommended for ceiling heights from the flooring up to 3 meters, provided the flooring surface is level, with a plain finish.

Ladders are not recommend for ceiling heights exceeding 3 meters, a Platform with 4-sided pillars is recommended.



Wrong standing position



Right standing position

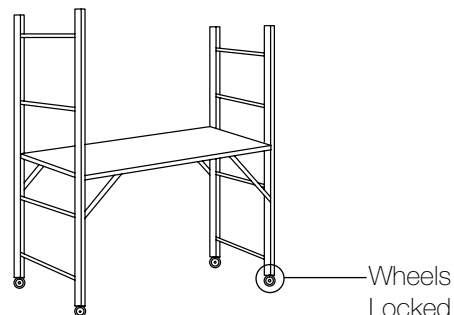

Platform

Armstrong recommends that installers wear a tool belt for easy access to tools during installation.





It is unsafe to keep tools on the ceiling tiles.



Safety & Precautions

Personal protective equipment (PPE):

Armstrong World Industries advocates a strong safety policy and thus all installers **MUST** wear PPE consisting of hard hat, rubberized gloves, jacket, steel toes and glasses during installation of the ceiling system.

Item	Description
 <p data-bbox="209 488 312 517">Hard Hat</p>	<p data-bbox="416 488 903 546">Prevents injury to the head from small falling objects at construction site.</p>
 <p data-bbox="153 857 368 920">Rubberized Gloves (CL3)</p>	<p data-bbox="416 857 922 887">Prevents injury to the hand from flared edges.</p>
 <p data-bbox="225 1160 296 1189">Jacket</p>	<p data-bbox="416 1160 834 1218">Provides better visibility at low visibility construction site.</p>
 <p data-bbox="217 1503 308 1532">Glasses</p>	<p data-bbox="416 1503 970 1561">Prevents small particles while cutting from entering into the eyes and causing injury.</p>
 <p data-bbox="201 1738 320 1767">Steel Toes</p>	<p data-bbox="416 1738 930 1796">Prevents toe injury due to sharp or obstructive objects laying on the floor.</p>



Tools

Measuring Tape:



Distance meter:



Line laser leveler:



Chalk line:



Hand drill /driver:



Rotary hammer machine:



Wire snip:



Aviation snip:



Clamp:



Knife:



Pop Rivet:



Slitting shear machine:



Maintenance

Standard Maintenance

Armstrong Ceiling Systems require no more maintenance than painted drywall ceilings. However, when maintenance is necessary, certain procedures should be followed to insure continued high performance and attractive appearance.

Dust and loose dirt may easily be removed by brushing or with a vacuum cleaner. Vacuum cleaner attachments such as those designed for cleaning upholstery or walls do the best job. Be certain to clean in one direction only. This will prevent rubbing dust into the surface of the ceiling. After loose dust has been removed, pencil marks, smudges, or clinging dirt may easily be erased with an ordinary art gum eraser.

Armstrong metal ceilings may be cleaned with a moist cloth or a sponge dampened in water containing mild soap. The sponge should contain as little water as possible. After washing, the soapy film should be wiped off with a cloth or sponge slightly dampened in clean water.

Checklist For Lay-in Ceiling Installation

Project Name : _____

Area : _____ m²

Location: _____

Phase	<input checked="" type="checkbox"/>	Activity
i. Preparation Phase		
Storage	<input type="checkbox"/>	Store materials at site in a covered space isolated from ground free of undulations, debris, humidity and precipitation.
	<input type="checkbox"/>	Material should be free of damages (Inspect material to assess damages, if any).
Drawings	<input type="checkbox"/>	Reflected ceiling plan (RCP) and sectional drawings received from Architect and duly verified for suitability of installation at site and services like lights, AC diffusers correctly marked in the drawings.
Site preparation	<input type="checkbox"/>	All relevant work that precedes ceiling installation have been completed (e.g. the drywall perimeter, AC ducts, cable trays, under-deck insulation) before commencing ceiling installation.
Ceiling height	<input type="checkbox"/>	Has been approved by the concerned authority.
Installation phase	<input type="checkbox"/>	All work completed as per co-ordinated drawing.
ii. Suspension accessories		
Anchor Fasteners		<p>Precondition:</p> <input type="checkbox"/> Marked location on structural soffit on the basis of the ceiling plans issued by the Architect. <input type="checkbox"/> Suspension wires located and fixed at 1200mm centre-to-centre max and not more than 600mm away from wall/perimeter. <input type="checkbox"/> Suspension wires are not above services like HVAC ducts or any other obstruction/provided additional suspension (trapeze installation method) locations to ensure verticality of hanger and adequate transfer of load.
		<p>Material:</p> <input type="checkbox"/> Minimum M6 Grade Anchor Fasteners/appropriate quality used/procured.
		<p>Installation:</p> <input type="checkbox"/> Appropriate hole size for inserting the anchor fasteners. <input type="checkbox"/> Anchor fasteners fixed and secured properly to take the load of the ceiling hanger wire.
		<p>Precondition:</p> <input type="checkbox"/> Anchor fasteners fixed properly at appropriate locations. <input type="checkbox"/> Location of suspension wires such that they can be hanged vertically without obstructions.
		<p>Material:</p> <input type="checkbox"/> Minimum 12 gauge hanger wires (i.e. 2-2.6mm diawires) used/procured. <input type="checkbox"/> Hanger wires procured/used are pre-straightened- no local kinks or bends (Ideally, machine-straightened wires recommended). <input type="checkbox"/> Appropriate gauge of wire used to suite quick hangers/ hook or butterfly clips.
		<p>Installation:</p> <input type="checkbox"/> Hanger wires cut to appropriate size (ceiling drop +150mm to 200mm allowance for tying on either ends). <input type="checkbox"/> Top and bottom ends secured to the anchor fastener and grid/quick hanger respectively with minimum three tight twists within 75mm of the ends. <input type="checkbox"/> Wire adjusted appropriately to ensure that the grid is in perfect level (verified using laser leveller). <input type="checkbox"/> Hanger wires should be perpendicular after grids are suspended (a maximum 5 degree variation allowed). <input type="checkbox"/> Distance of hanger wires from the base of slab should not be greater than 1.8mtr. <input type="checkbox"/> If hanger wire distance from the base of slab is more than 1.8mtr., counter splaying wires installed.
Quick hangers (optional)		<p>Precondition:</p> <input type="checkbox"/> 2.5mm of hanger wire is used to suit the quick hanger/hook clip. <input type="checkbox"/> Hanger wires are maintained absolutely straight to ensure line and level.
		<p>Material:</p> <input type="checkbox"/> Tensile strength of quick hangers (or hook clip of Armstrong) offers adequate resistance against movement of the hanger wire (pull test).

iii. Grid

Installation:

- Hanger wires secured to the quick hanger (or hook clips) with the other hanger wire (or the hook clip end) inserted into the rout hole of grid and secured.
- Level of the grid to be adjusted by pressing the ends of the clip/hanger and released to secure the hanger wire once the level has been appropriately adjusted.

Precondition:

- All relevant works like service ducts, cable trays, plastering and painting of walls, drywall perimeter trims, hanger wires have been completed.
- The site conditions, humidity, temperature etc., are as within control and very close to actual usage.

Material:

- All services like lights, A/C, fire alarms etc. are suspended directly from structural soffit.
- Suitable to tile edge (e.g. board, tegular, bevelled tegular, SL2, K2C2) and colour has been procured.

Installation:

- Wall angles installed first by securing to the wall or plaster trim at every 450mm max centre to centre (Incase of floating ceilings, the perimeter trims-Axioms should be installed after grid components).
- Main runners suspended preferably along the longer side of room/ceiling at every 1200 mm centre to centre.
- Main runners are not spaced more than 600mm from the perimeter.
- Hanger wire suspensions to main runners do not exceed 1200mm centre to centre.
- 1200mm cross tees placed across by spanning the main runners and be placed at every 600mm intervals.
- 600 mm cross tees are fixed by spanning 1200mm cross tees with the slots provided in the 1200mm cross tees.
- All the cross tees connected with each other from the right side (for proper alignment).
- Double locking in cross tees ensured.

iv. Tile

Precondition:

- The grid is in absolute line, level & squareness and as per the RCP.
- The tiles are acclimatized to the actual site conditions 24 hours before commencing installation.
- All service fixtures like 600x600 light fittings, AC diffusers and other service items are rested on the grid and independently suspended.
- 2mm gap given between corner tile and wall angle for ease of removal during maintenance.
- Protective cover removed on the metal tiles before placing the tile.

Material:

- Tile edges are suitable to grid (e.g. Prelude 24mm, Suprafine & Silhouette 15mm).
- Extra tiles (attic stock) are procured in case of damage of tiles during installation or after handover.

Installation:

- Service tiles (e.g. tiles carrying services like Speakers, Fire Alarm system, spotlights installed) first.
- Border tiles installed subsequently.
- Field cut tegular edges incorporated at perimeters (depending on edge detail) or shadow molding used (esp. in case of soft fibre tiles)/metal end cap used (in case of metal tiles with tegular edge).
- Field tile modules installed.

v. Commissioning Phase

Pre-handover checks

- Ceiling checked for line and level.
- Ceiling checked for squareness.
- Broken/damaged tiles checked and replaced with new tiles from attic stock.
- Tiles are cleaned and without stains.

Handover

- Joint inspection and handover by client representative and the ceiling installer completed.

Remarks: _____

Glossary

1. **Plenum:** The space between the main structural slab and suspended ceiling is called the plenum.
2. **Tegular:** A functional edge detail that allows a suspended ceiling tile to extend below the grid, making the grid less noticeable.
3. **Rout hole:** A hole on main runner to insert and lock the cross tees on the main tee.
4. **Plumb mark:** Measuring either from the floor or roof level and marking the ceiling height is known as plumb mark. From the plumb mark point, the entire ceiling level will be marked.
5. **Plaster bulk heads:** Plaster bulkhead is otherwise called Plaster board boxing. Plaster bulkhead is designed to accommodate HVAC grilles vertically.
6. **Flange:** The visible area of the grid from below the ceiling i.e. the horizontal surface on the face on the main runner or cross tee.

Knauf Ceiling Solutions (India) Private Limited

Boomerang, A-304, Chandivali Farm Road (near Chandivali Studio) Andheri (E), Mumbai - 400 072.

Contact us: 1860 266 7080 | e-mail : Helpdeskindia@knaufarmstrong.com

